

LightSync Digital

G3 Switch



Overview

The LightSync Digital G3 Switch Station is a modern, versatile and easy to use CAT-5 or 6 device. The G3 comes pre-configured as a Multi-Zone Dimmer, Scene Switch, Scene Multi-Zone Dimmer switch combination or a Non-Dim switch. The MZD supports 1-6 zone, Scene have 1-5 Scenes, Scene MZD stations support a 2S/4Z, 3S/3Z or 4S/2Z combo, the Non-Dim has 1-7 buttons. The dimming buttons allow Press-and-Hold Ramp-Up/Ramp-Down operation, holding a zone button on an MZD will select that zone for individual dimming. All scene buttons support capture of dimming levels to a scene by holding the scene button. G3 digital switches can control and display status for relays, groups, presets or scenes. Stations are also available with Bluetooth for programming and control from the ILC Pro app.

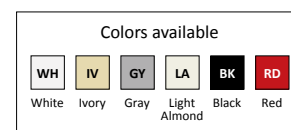

*wall plate cover not included

Features

- **Made in the USA, meets BAA and BABA requirements**
- **Bluetooth** option for programming and control from EVO-BT app
- **Field Configurable** between multi-zone switches, scene switches and non-dim switches
- **1 to 7 button** zone control configurations
- **Multi-Zone Dimming** for up to 6 zones and All-Off
- **Scene Station** with dimming for up to 5 scenes and All-Off
- **Scene Multi-Zone** with dimming combo for up to 4 Scene or Zones (2S/4Z, 3S/3Z or 4S/2Z) option
- **Scene Capture** operation for all stations with scene buttons
- **Raise and Lower Buttons** for ramp up and ramp down feature
- **Press and Hold dimming** operation
- **Status LEDs** indicate true state of relay, group, last scene or preset
- **Switch Locator** LED helps find the switch in a dark room
- **Laser engraving** is provided, and custom engraving is available, Black and Red buttons are pad-printed
- **Color Change Kit** available for White, Ivory, Gray, Red, Black and Light Almond
- **Addressable** rotary switches
- **Decora®** style single-gang switch plate available upon request

Warranty

Five-Year limited warranty

Ordering

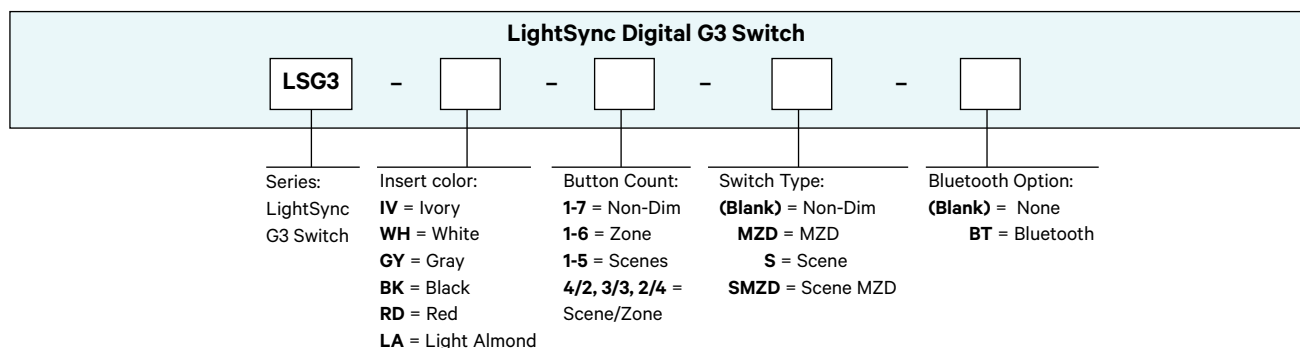

All ILC product configurations are built to be compliant with the Buy American Act of 1933 (BAA) or the Build America Buy America Act (BABA). BABA is the minimum Government compliance requirement for the Build America Buy America standards which is part of the Infrastructure and Investment Jobs Act (IIJA). Individual Government Agencies may have more stringent compliance standards. Please refer to the DOMESTIC PREFERENCES website or consult the CLS Domestic Preferences team for more information. Components shipped separately may be separately analyzed under domestic preference requirements.

Physical

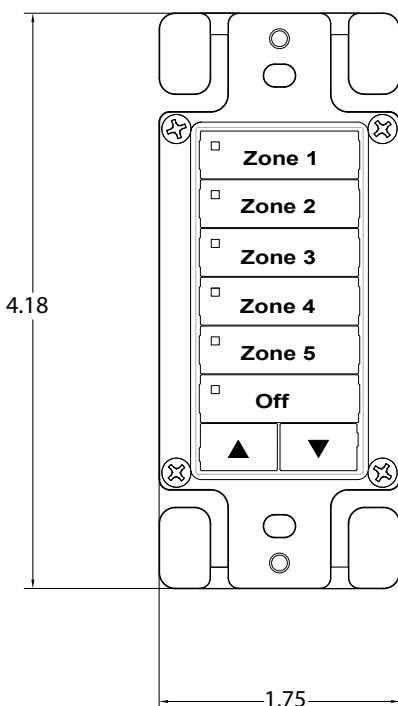

LightSync G3 Switch Cover Plate Mounting

LightSync G3 digital switches can be installed with a Decora or GFCI cut out face plate. Test the place fit and operation when installing the device for the best fit.

Recommended Decora plates:

- Leviton 84401-40 Stainless Steel plate
- Leviton 80401 Thermoplastic Nylon
- Pass & Seymour Legrand Trade Master Thermoplastic

Non-Compatible cover plates:

- Pass & Seymour Legrand 302/304 Stainless Steel
- Pass & Seymour Legrand SS26
- Mulberry 97401 Stainless Steel
- Eaton PJ26W
- Hubbell NP26

Small or narrow cover plates such as the P&S SS26 designed for a surface mounted handy box, when used on a sheet rock wall installation will not sit flush. Plates with additional material on the back of the plate may cause the installed plate to float free from the wall or for the Decora face of the switch to be excessively recessed from the face of the plate.

Specifications

Physical:

- Recommended for single-gang switch box mounting only (Not compatible with multi-gang, round-cornered mud rings)
- Digital addressing switches
- RJ45 connectors provided for easy connection
- Mounting screws provided
- Laser engraving standard as shown, Black and Red buttons are pad-printed
- Custom engraving available

Electrical:

- Powered from the panel or LightSync network

Operating Environment:

- Location: Interior space
- Operating Temp.: 0° to 50° C
- Humidity: 10% - 90% Non-condensing
- Atmosphere: Non-explosive/corrosive
- Vibration: Stationary

Domestic Preferences:

Domestic preference options to meet BAA or BABA requirements. BABA is the minimum Government compliance requirement for the Build America Buy America standards which is part of the Infrastructure and Investment Jobs Act (IIJA). Individual Government Agencies may have more stringent compliance standards. Please refer to the [DOMESTIC PREFERENCES](#) website or consult the CLS Domestic Preferences team for more information. Components shipped separately may be separately analyzed under domestic preference requirements.

Certifications and Approvals:

- UL, cUL
- FCC Part 15

See Technical Bulletin TB0620 for switch plate compatibility.

LightSync Digital **G3 Switch**

Configurations

G3 Scene MZD Stations

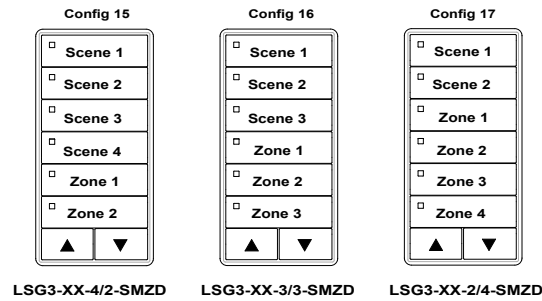

G3 Scene Stations

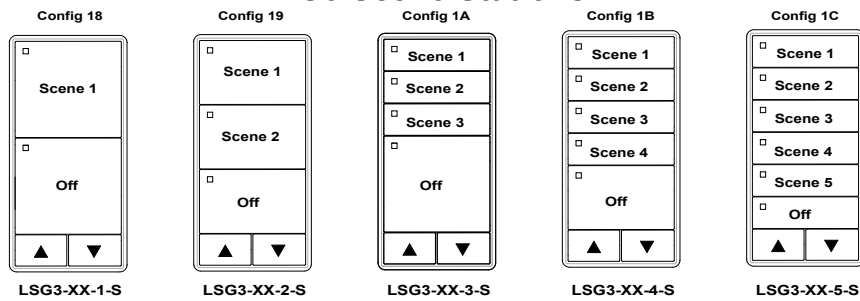

G3 MZD Stations

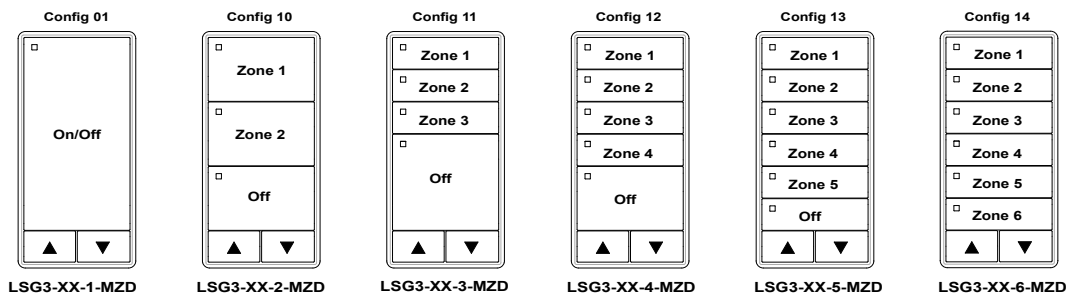

G3 Non-Dim Stations

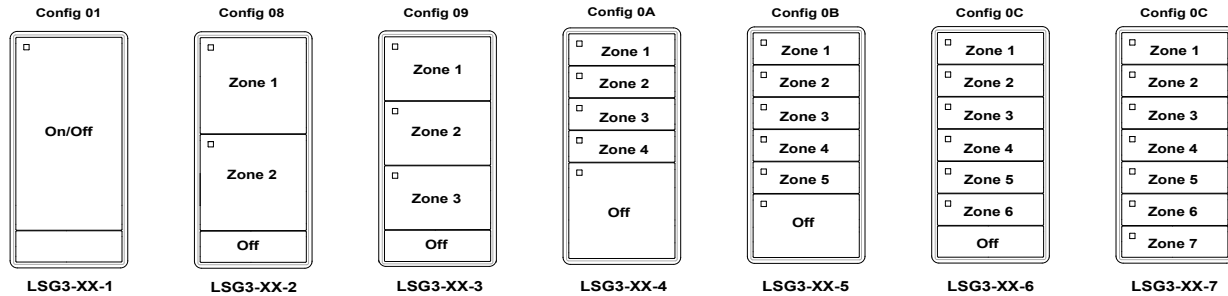

See Technical Bulletin TB0620 for switch plate compatibility.